

Kippenhok Toby

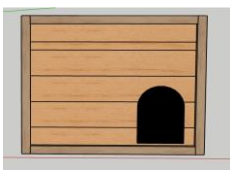

Benodigheden:

- Schroefmachine
- Rolmaat
- Bit pz2
- Bit pz1
- Boortje 4mm (is meegeleverd)
- *ALLE SCHROEVEN VOORBOREN***



1x



1x



2x



2x

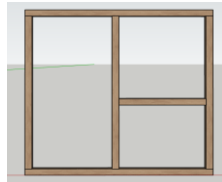

1x

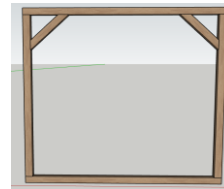

2x

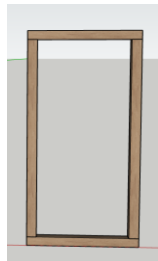

1x



4x



1x



1x

Dakbedekking
-1x 360x95cm



Spie
-5x 85cm



Lat

- 2x 71,4cm (30x16mm)
- 2x 34cm (65x16mm)
- 2x Daktrim 121,5cm
- 2x Daktrim 95cm
- 1x Daktrim 120cm



Balk 44x44mm

- 2x 79cm
- 3x 120cm
- 1x 57cm



Overige

- 1x Legbak
- 4x Geheng 20cm
- 2x schuifslot

- 51 Schroef 70mm
- 13x Schroef 40mm
- 62x Schroef 30mm
- 16x Schroef 20mm

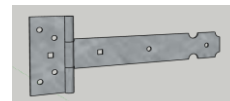
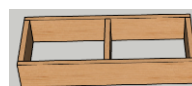
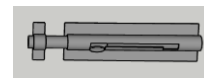

1.

2x Lat 30x16mm - 2x 71,4cm
6x Schroef 30mm

8mm

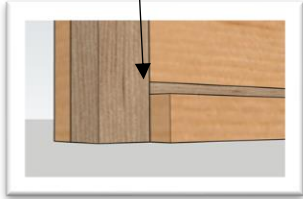

2.

3x Schroef 70mm



Onder/bovenaanzicht

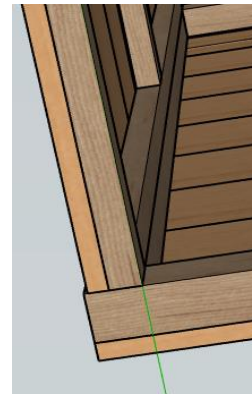

3.

3x Schroef 70mm



4.

3x Schroef 70mm



5.

3x Schroef 70mm

Onder/bovenaanzicht

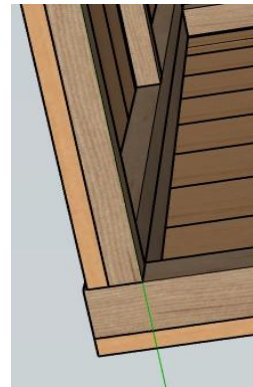

6.

3x Schroef 70mm

Onder/bovenaanzicht

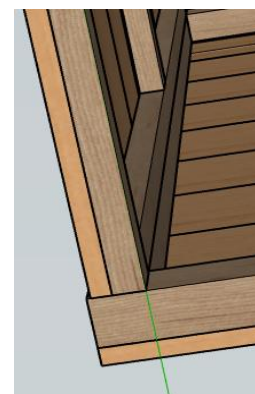
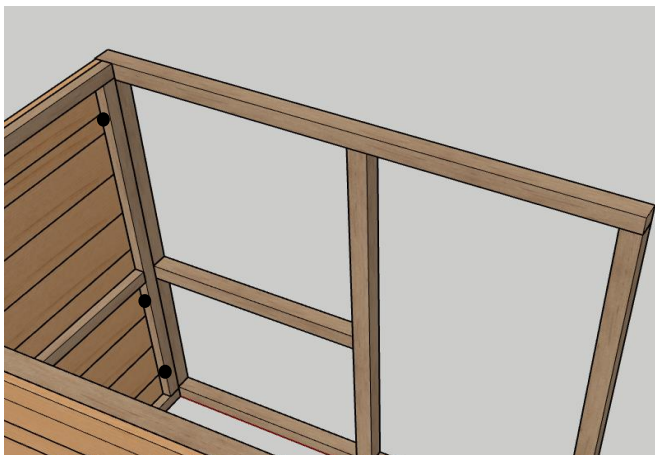

7.

4x Schroef 70mm

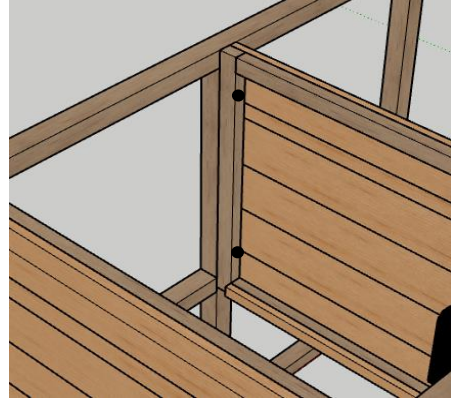
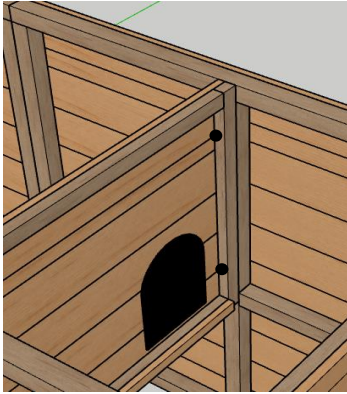

8.

3x Schroef 70mm



9.

6x Schroef 70mm

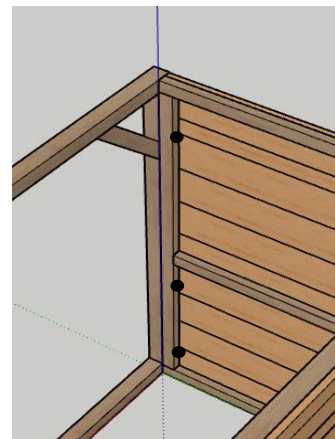

10.

1x betonplex 55x85cm

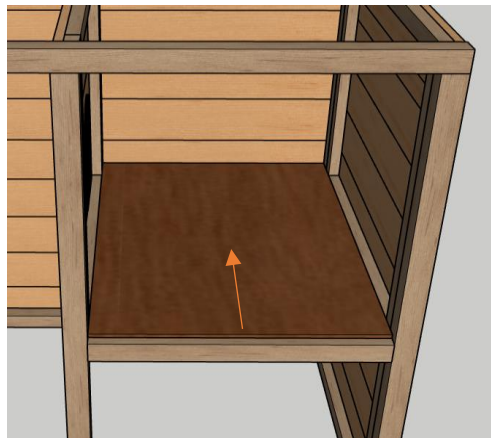

11.

4x geheng 20cm
12x Schroef 30mm

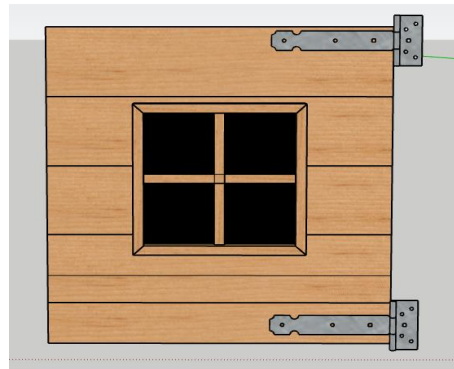
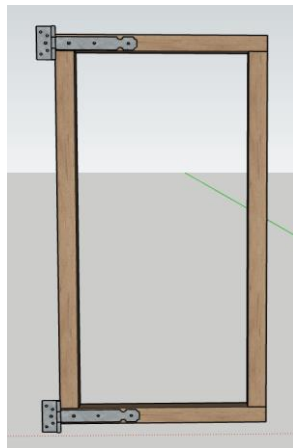

12.

2x Schuifslot
8x Schroef 40mm
16x Schroef 20mm

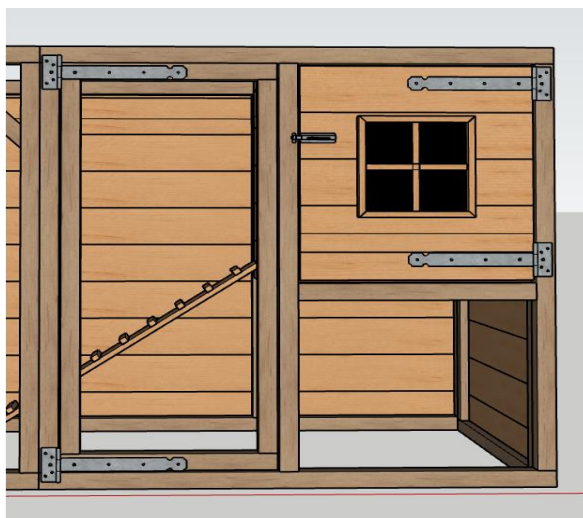

13.

2x Lat 65x16mm - 34cm
1x Balk 44x44mm - 57cm
1x Legbak
12x Schroef 30mm

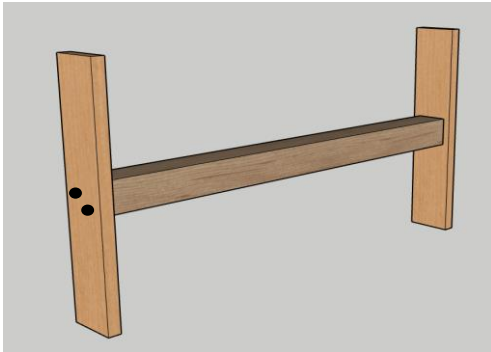

1.



2.

14.

2x Balk 44x44mm - 79cm
8x Schroef 70mm

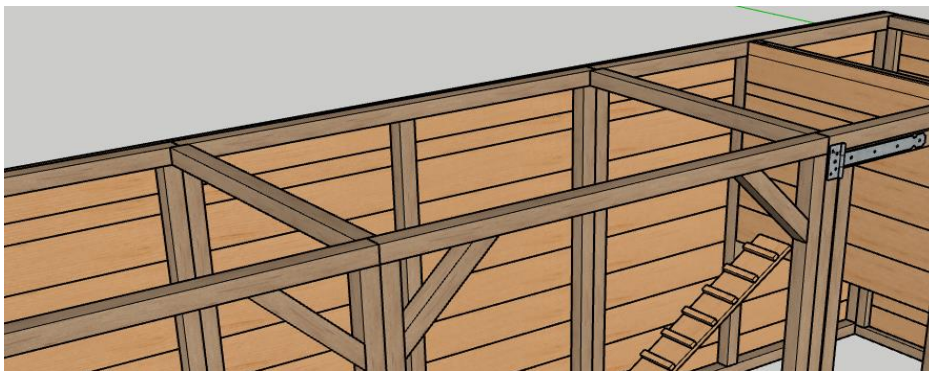

15.

3x Balk 44x44mm - 120cm
9x Schroef 70mm

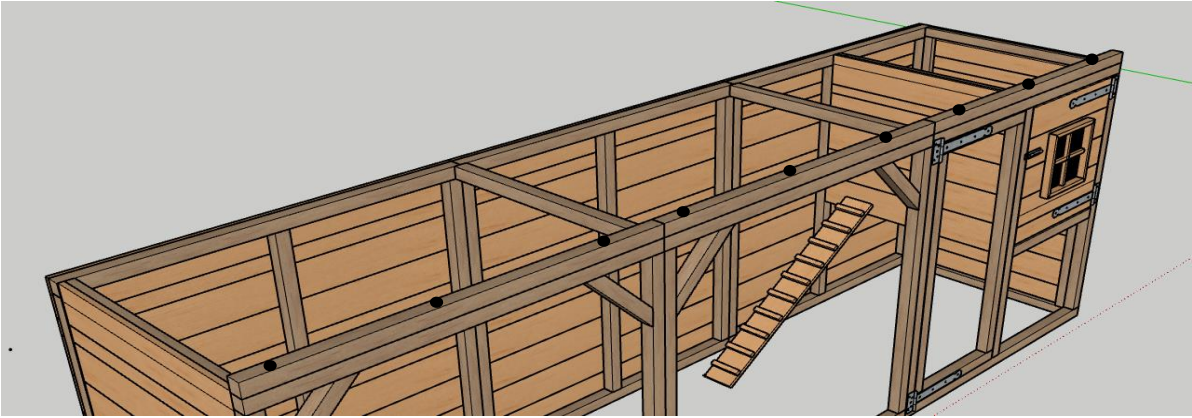

16.

5x *spie* 85cm
5x Schroef 70mm
5x Schroef 40mm

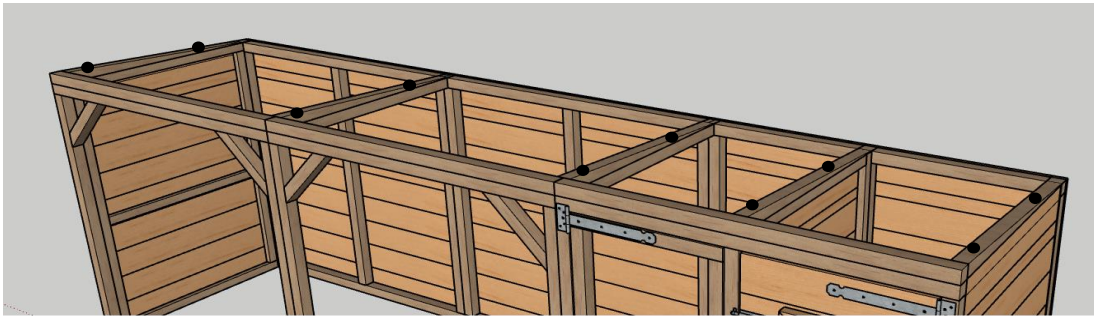

17.

2x betonplex 117,8x91,8cm
1x betonplex 120x91,8cm
18x Schroef 30mm

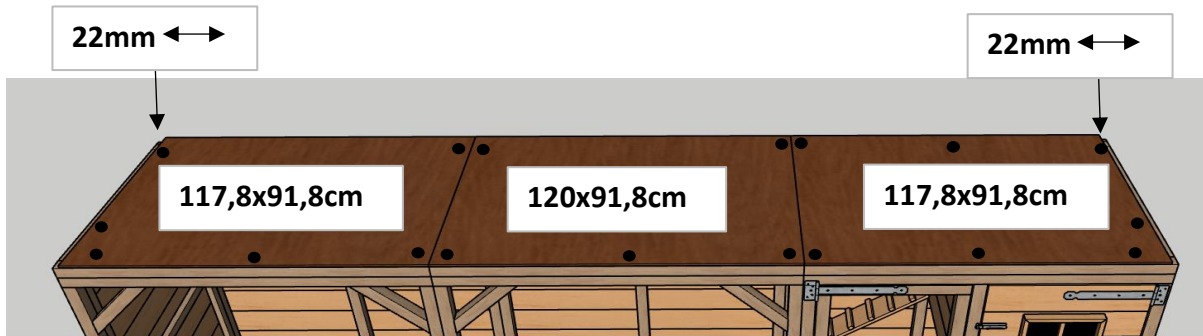

18.

1x dakbedekking 360x95cm



1.
Verdeel de dakbedekking over de betonplex platen. Zorg dat de smalle strook folie aan de boven en voorzijde zit. Verwijder hierna de folie.



2.
Verwijder de folie van de onderzijde en verdeel hierna de dakbedekking over de betonplex platen.

-Voorzijde gelijk
-Linker + rechterkopzijde gelijke overstek
-Achterzijde steekt door.



19.

2x Daktrim 95cm
2x Daktrim 121,5cm
1x Daktrim 120cm
20x Schroef 30mm

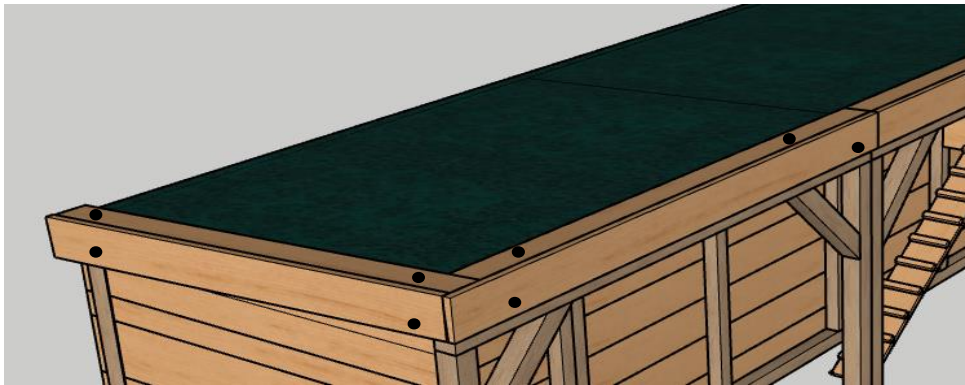
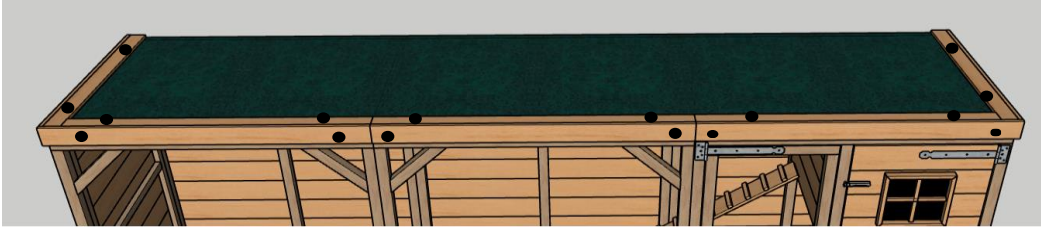

Legnest



4x Schroef 60mm
4x Schroef 40mm
16x Schroef 30mm

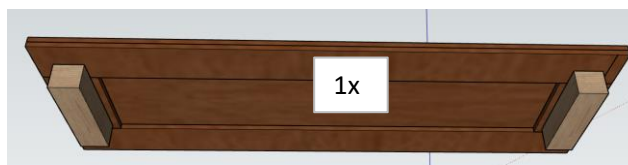
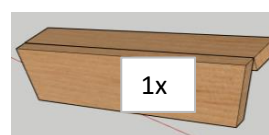
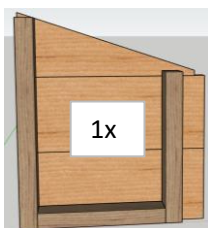
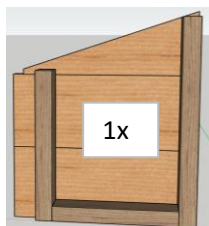
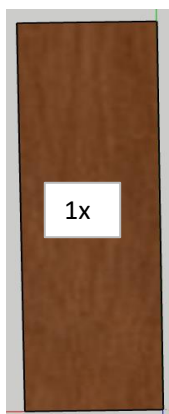

1.

2x schroef 40mm

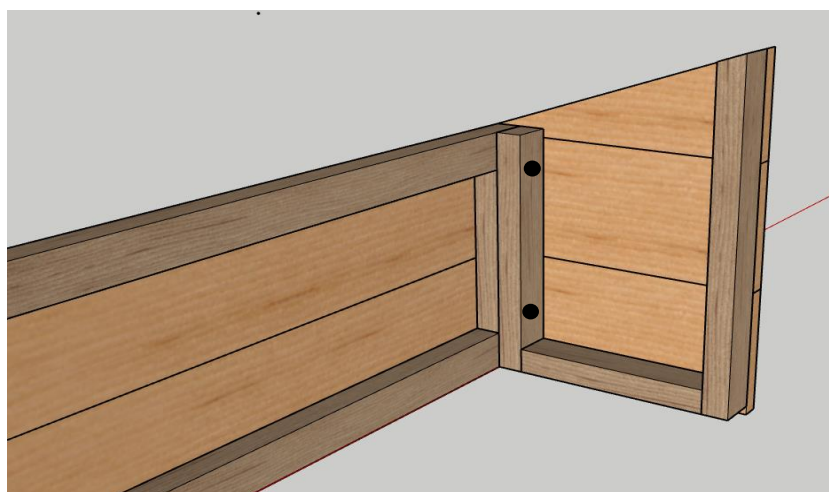

2.

2x schroef 40mm



3.

8x schroef 30mm

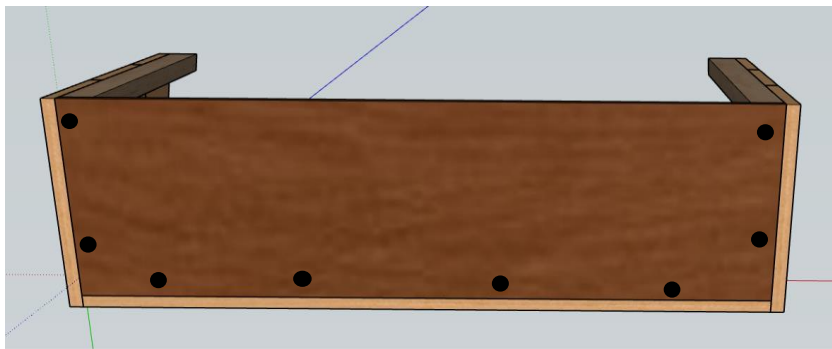

4.



5.

1x dakbedekking 34x85cm

Plak de dakbedekking op de deksel

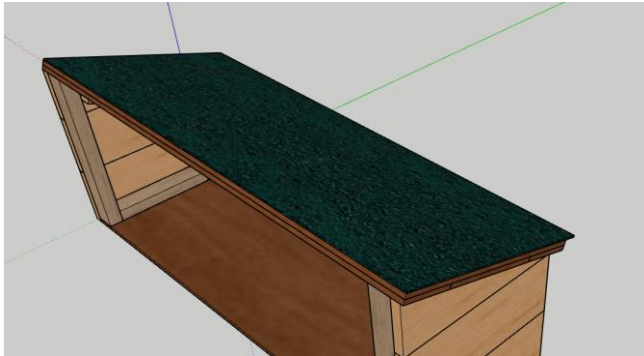

6.

8x Schroef 30mm

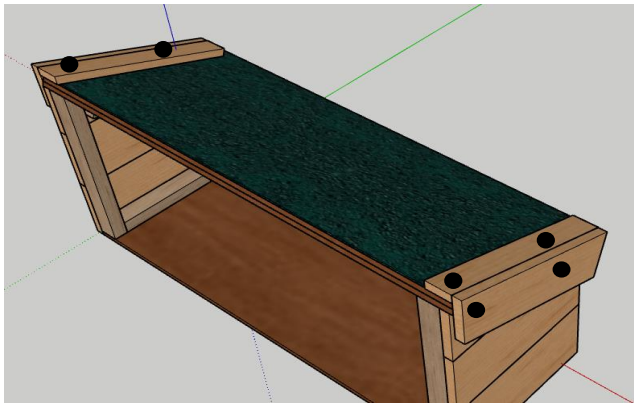

7.

Verwijder twee planken aan de kopzijde



8.

4x schroef 60mm

16mm

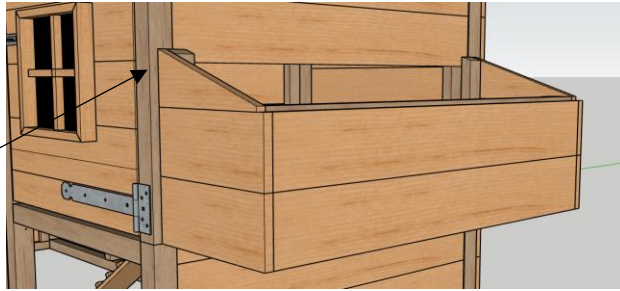

54,4cm

